

Perfis para

Steel Frame

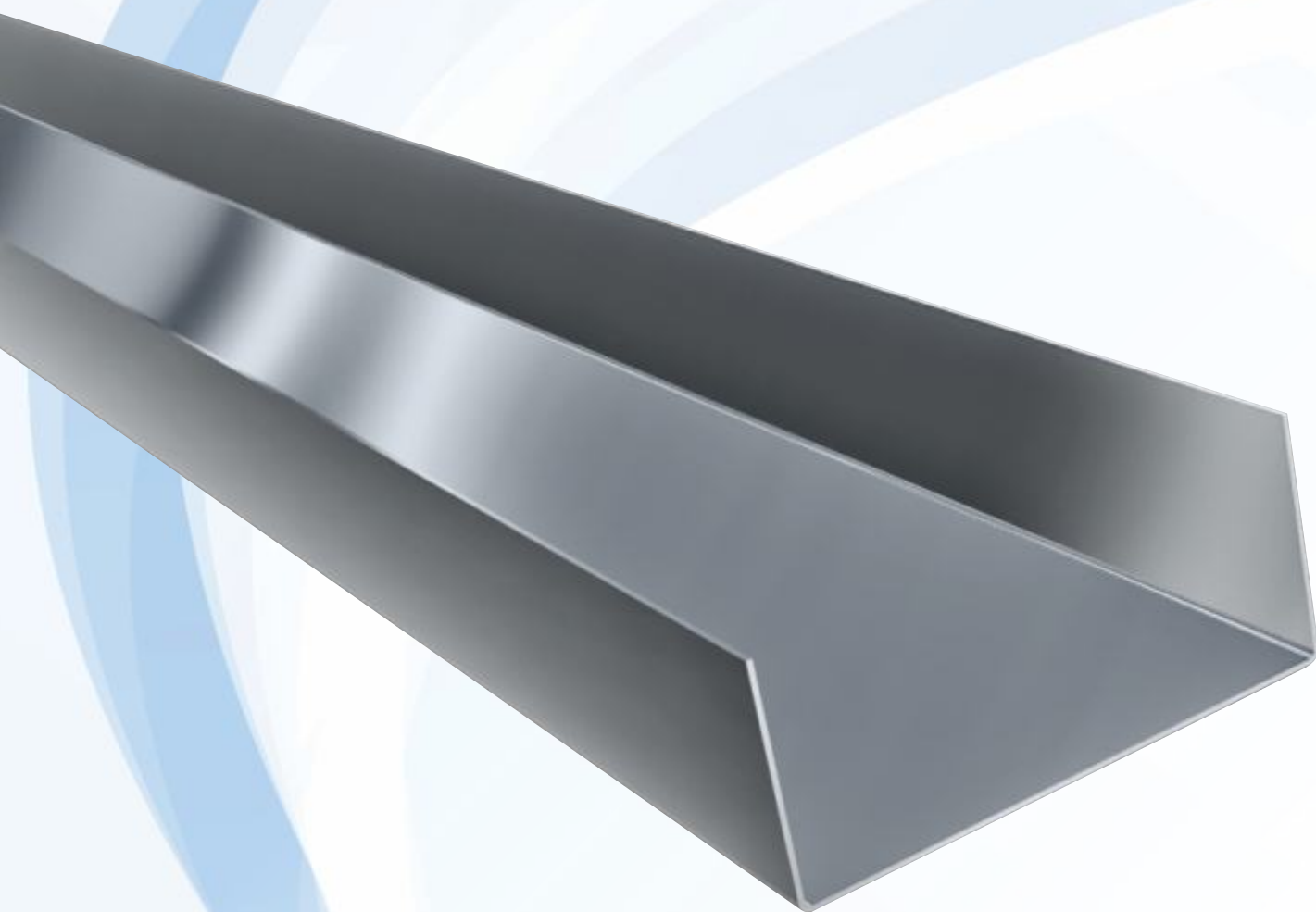

alge®

Indústria Metalúrgica Ltda.

Perfis para Steel Frame

MONTANTES



MONTANTE 90



MONTANTE 140



MONTANTE 200



Perfil utilizado verticalmente na composição de painéis de paredes.

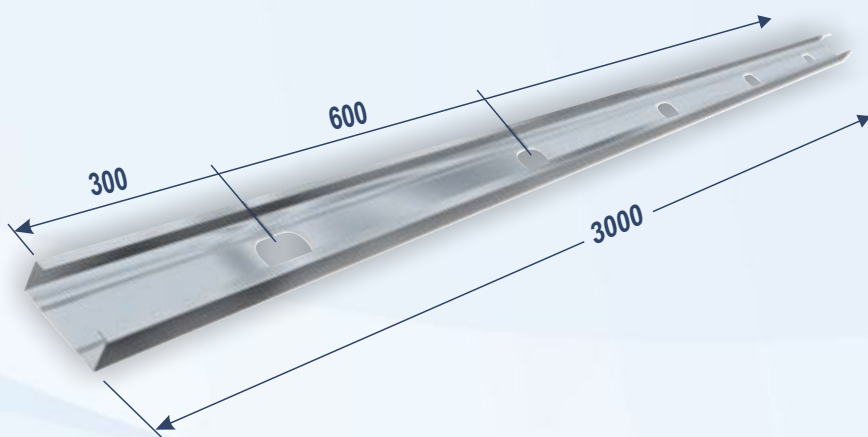

GUIAS



GUIA 90

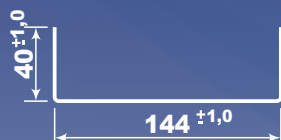

GUIA 140



GUIA 200



Perfil utilizado como base e topo de painéis de parede e encabeçamento de estruturas de entresijos e telhados.



RIPA

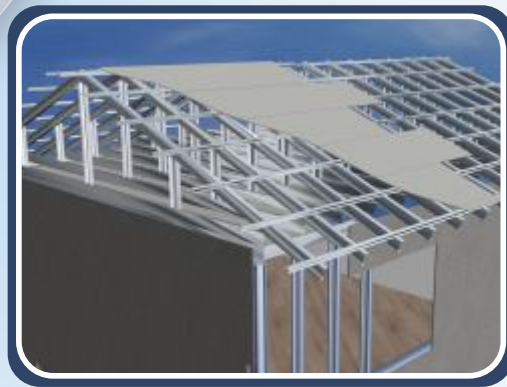
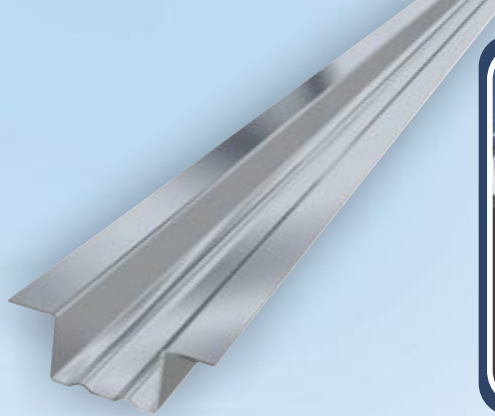
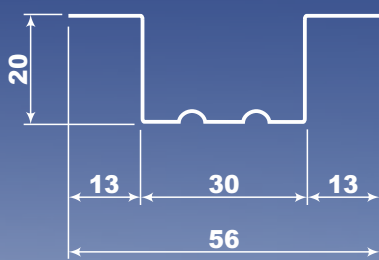

Perfil utilizado para apoio de telhas, placas de revestimentos ou painéis de cobertura.

Acessórios Steel Frame

Fita de Contraventamento

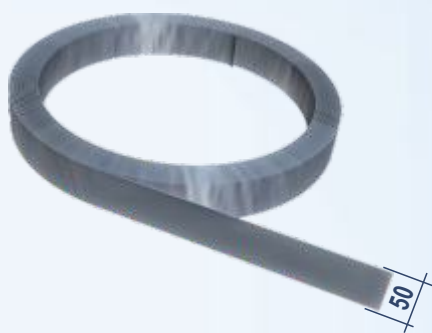

Conector de Ancoragem



Placas Gousset

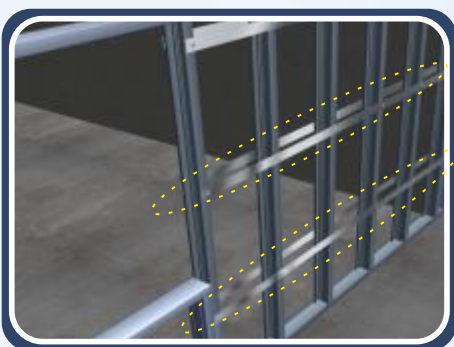
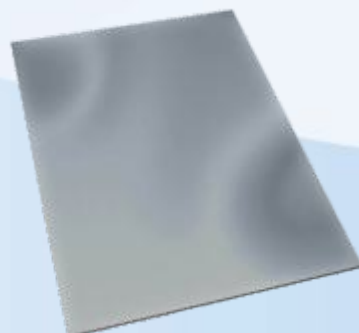

Fita de Contraventamento - Aplicação



Conector de Ancoragem - Aplicação

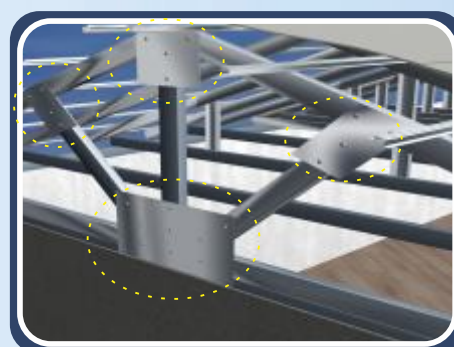

Placa Gousset + Aplicação Tesoura

Vantagens de adquirir produtos da marca ALGE:

- Preços competitivos
- Pronta entrega
- Qualidade assegurada
- Atendimento personalizado

A MARCA ALGE É RECONHECIDA PELA EXCELÊNCIA NO ATENDIMENTO AO CLIENTE E PELA INOVAÇÃO E QUALIDADE NA FABRICAÇÃO DE SEUS PRODUTOS.

Aguardamos seu contato

Tel: +55 (11) 2701-2060

Rua Padre Isidoro, 83/115 - Vila Nova York - CEP 03479-020 - São Paulo - SP

alge[®]

INDÚSTRIA METALÚRGICA
www.algemetalurgica.com.br